

sensorProbeX+ (SPX+)

Customizable Modular Design



Select from a standard configuration, or build your own customized monitoring solution. Choose a mounting options to suit your installation, whether it be 1U, 0U rack mounting, or DIN rail. Optional modules, internal DC power supply, PoE and Cellular modem can be selected depending on your requirements.



SPX+ is compatible with all AKCP sensors, including the latest “smart sensors” such as swing handle locks, cabinet thermal maps, LCD display and battery monitoring sensors.

Every SPX+ features an EXP port, which functions as an RS485 Modbus port as well as connecting with AKCP Expansion modules.

A Basic Expansion Bus (BEB) port expands to additional SPX+ modules. A maximum of 4x BEB units can be connected to a single SPX+

Monitor multiple SPX+ units from AKCPro Server for centralized monitoring and management of all devices.

SPX+ - Modules



MCU

The MCU Module is the core of the SPX+. A mandatory module it forms the base configuration of every unit. 4x intelligent sensor ports, Ethernet and a dual purpose Expansion (EXP) port for Modbus RS485 communications, or connection to AKCP Expansion. Basic Expansion Bus (BEB) port connects the SPX+ to SPX+ basic expansion units comprised of additional SPX+ modules.

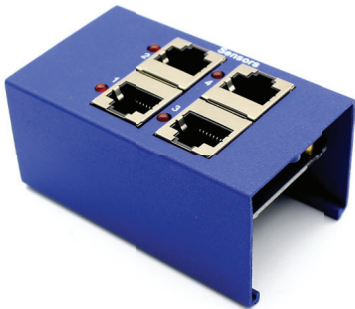

sensor4

sensor4 modules give additional intelligent sensor ports, allowing you to build your SPX+ to your requirements. Connect a wide range of intelligent sensors and smartRack sensors such as Cabinet Thermal Maps, Programmable LCD Display and RFID Swing Handle Locks.

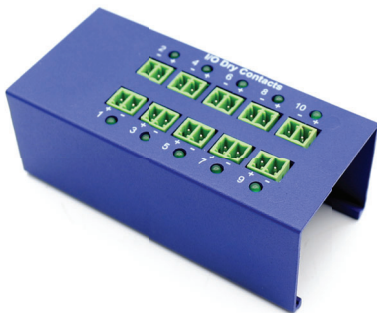

Dry Contacts

Dry contact modules can be added in x10 and x20 blocks. The dry contacts can be ordered as I/O, isolated input only (internal 5V) and isolated input only (external 5-20V). Dry contacts can be used to monitor a variety of third party devices and alarm panels

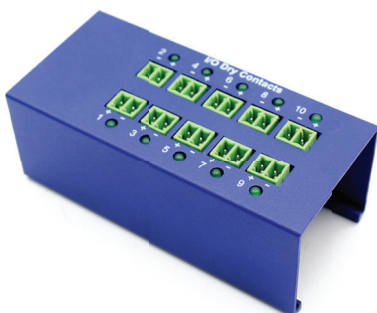

AC Voltage Detection

Monitor 10x or 20x AC Voltage inputs, detect if circuits are energized or not. This module does not give a voltage reading, only the presence or absence of AC Voltage. Voltage range is 5-30ACV @ 44mA.

SPX+ - Modules

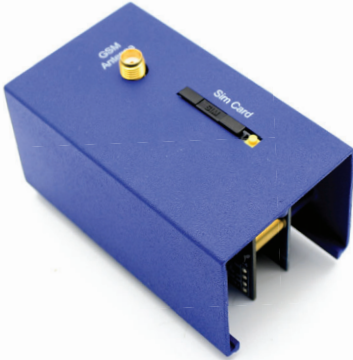

Cellular Data Modem / GPS

4G Cellular Data Modem module gives a primary or backup method of communication. Send SMS and e-mail alerts directly from the device through the cell network. Ideal for remote site locations and those with unreliable DSL connection.

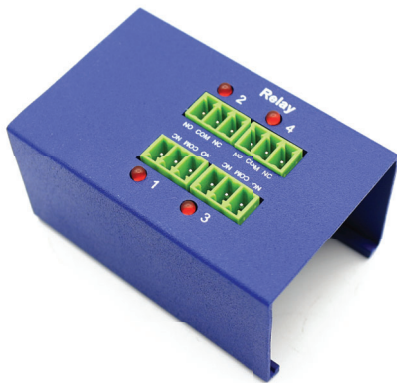

4x Mini Relays

This module includes 4x mini DC relays. Use them to switch on/off low current devices directly, or use them to drive larger relays. Ideal for systems and control, building and industrial automation.

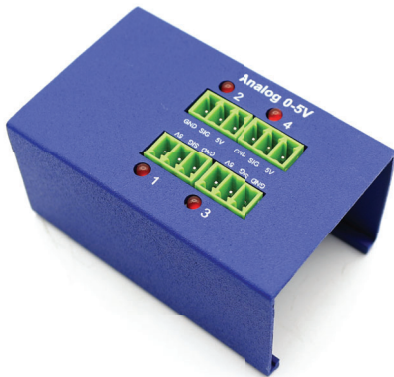

4x Analog to Digital Inputs

This module is ideal for connecting third party analog sensors with a 0-5VDC or 4-20mA scale output. Many industrial sensors are available with this scale output, opening up the possibilities of monitoring many different sensors not provided by AKCP.

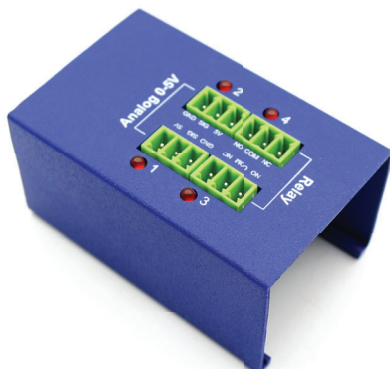

2x Mini Relays & 2x Analog Inputs

This module is a combination of the above modules, with 2x relays and 2x 0-5VDC or 4-20mA analog sensor inputs.

SPX+ - Modules



Valve Control Module

If you have DC motors or electronically controlled ball valves which require polarity reversal to turn in the opposite direction, this module is applicable. Ideal for water irrigation or industrial applications which require valve and motor controls.



Internal Mini UPS

This module is useful in situations where the SPX+ may face power outages. An internal battery backup using 4x AA batteries can power the SPX+ for several hours (depending on sensors connected, alerts generated etc). This is ample time to be able to continue to send alerts, and most importantly notify you of the power situation so the main power can be restored.

Ideally combined with the internal cellular data modem, SMS alerts can be sent even if the rest of your network is down.

Mounting	Internal
Power	Input Voltage 5.5V 4x AA NimH batteries
Charger	Slow Charge circuit for long lasting batteries
Status Indication	Red LED indication for On Battery Status Green LED indication for charging status
Components	Manufactured using highly integrated, low power surface mount technology to ensure long term reliability.
Operating Environment	Temperature : Min. -35° C – Max.80° C Humidity: Min. 20% – Max. 80% (Non-Condensing)
MTBF	1,400,000 Hours based on field experience with sensorProbe units.
Other	For SPX+ series only

Online Configuration

Customize your SPX+ with our online configuration tool, graphically build up your device with the modules you need and submit for quotation.

SPX+ - Expansion

Basic Expansion Bus (BEB)

Using an SPX+ Master with BEB, together with SPX+ Basic Expansion Bus devices, you can increase the number of sensor ports, and dry contacts available. Recommended for use over a short distance, within the same cabinet only, it provides a cost effective way to expand your system. The maximum distance from the SPX+ Master to the last unit in the chain is 10 meters.

4x BEB - Max total cable length 10 meters

3x BEB - Max total cable length 18 meters (3x 6m)

2x BEB - Max total length 20 meters (2x 10m)

1x BEB - Max total length 20 meters (1x 20m)



RS485 Expansion (EXP)

Using an SPX+ Master with EXP, together with EXP units you can add dry contacts and sensor ports to your system, with the ability to place the units up to 300 meters (1,000ft) away from each other. Supported EXP devices are the E-Sensor8 and E-Opto16 Expansion units.



Max
300 Meters

EXP Unit

Max
300 Meters

EXP Unit

SPX+ - Dual Power Inputs

Dual Power Inputs

The SPX+ is available with an internal 12-24 VDC or 48-60 VDC power supply. This power supply features dual inputs with redundant fail-over. Ideal for telecoms where DC power is available directly in the cabinets.

It can also be utilized in a data center with a dual PDU setup. Connect the 220VAC-12VDC power adapters to the separate AC power sources, and the output of the 12VDC adapters to the SPX+.

If the SPX+ features the Power over Ethernet (PoE) option, this can also be used as a redundant power input. If the power source to the DC jack is interrupted the SPX+ will switch to the PoE source.

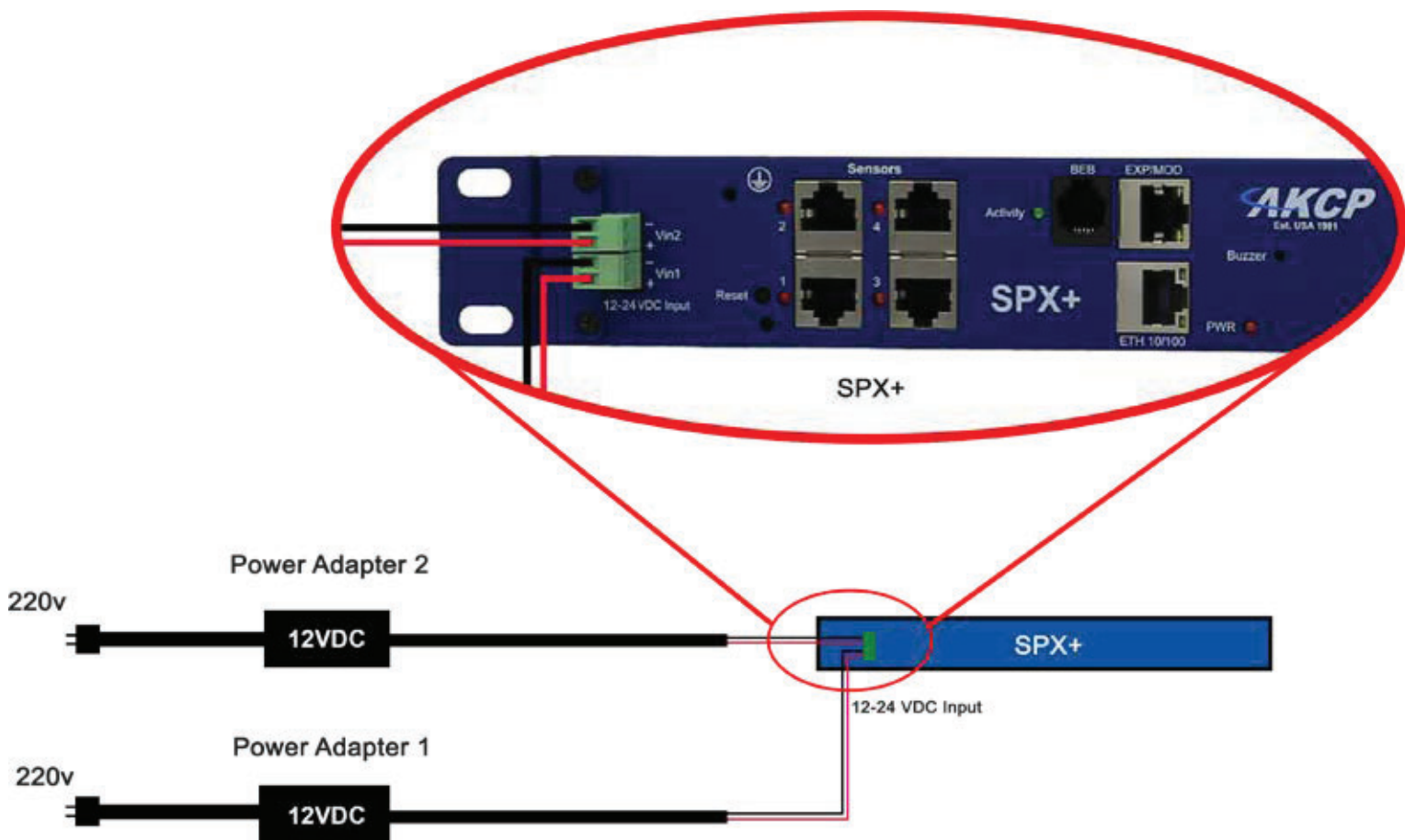

The dual DC inputs are also available as an external converter under product codes DCW024-5 and DCW048-5

SPX+ Technical Specification

Dimension	44 (W) x 44 (H) low profile design
Expansion Port *	EXP port connecting EXP Remote Units BEB port for connecting SPX+ BEB Remote Units
Mounting	0U Toolless rack mount, optional wall mount brackets, horizontal 1U mounting or DIN rail brackets.
Power	External 5.5V 3A Power Adapter Input Voltage and Current ratings : 100V~240V - 0.22A Options: Power over Ethernet (PoE) Dual 12-24VDC internal power supply Dual 40-60 VDC internal power supply
Status Indication	LED indication for power LED for network connectivity LED for sensor online and threshold status Internal Buzzer for audible alerts
Components	Manufactured using highly integrated, low power surface mount technology to ensure long term reliability.
Operating Environment	Temperature : Min. -35° C – Max.80° C Humidity: Min. 20% – Max. 80% (Non-Condensing)
MTBF	1,400,000 Hours based on field experience with sensorProbe units.
Base Unit	4x Sensor Ports for connecting AKCP sensors 1x Expansion Out or Modbus RS-485 Port (supports up to 4 CCU, E-Sensor8 or E-Opto16) 1x Basic Expansion Bus Port (BEB) 1x 10/100 Mbps Ethernet Port
Max Sensors	Maximum of 150 onlined sensors, including Expansion Units and virtual sensors.
SPX+ Modules	<ul style="list-style-type: none"> - 4x Sensor Ports module for connecting AKCP sensors or swing handle cabinet locks - 10x or 20x Dry Contacts module, 3 configurations : <ul style="list-style-type: none"> + Configurable Input / Output dry Contact (0VDC/5VDC) + Input only 5V Dry Contact, opto-coupled input + Isolated input Dry Contact, from 5V to 20V voltage input signal + Isolated AC Detection input 5-30ACV @44mA - 4x Mini relays for driving larger relays - 4x 0-5VDC / 4-20mA input for third party sensors - 2x 0-5VDC / 4-20mA input for third party sensors with 2x Mini relays - Valve controller module
Optional	Internal mini UPS, 4x AA rechargeable batteries Internal 40-60V DC power supply 4G Cellular data modem with external antenna Power over Ethernet (PoE) Internal DC Power Supply
Maximum Number of Access Control Users	500 Users 100 Users default
Supported Protocols	Rsyslog MQTT / MQTTS SNMP V1/2 IPV6 RADIUS TACACS HTTPS Encrypted E-mail
Licensing	
Virtual Private Network (VPN) : VP	VPN - Connect to AKCPPro Server from your base unit through VPN over Ethernet or cellular network.
Virtual Sensor pack : VS	Virtual sensor (pack of 5 sensors). Maximum of 80 virtual sensors. * ** Every SP2+ comes with 5 free virtual sensors
3rd Party PMS & Modbus : PM	3rd Party Modbus / PMS device. Up to 4 modbus devices with 15 sensors.* **
500 Access Control user database : UA	500 users for access control (SP+ series has 100 users as standard)
IPV6 : SP-IPV6	Support for IPV6 network addresses
Radius : RAD	Radius user authentication server connection. TACACS authentication to Radius.
Important Notes	* the sensorProbe+ units can only have 60 Modbus RS485 sensors (virtual sensor + modbus devices) ** the sensorProbe+ units can only have 60 Modbus TCP/IP sensors (virtual sensor + modbus devices)

SP+ 4G Modem (M4E / M4U) - Technical Specification

Frequencies	<p>EU model :</p> <ul style="list-style-type: none"> • LTE-TDD B38/B40/B41 • LTE-FDD B1/B3/B5/B7/B8/B20 • UMTS/HSPA+ B1/B5/B8 • GSM/GPRS/EDGE B3/B8 <p>US model :</p> <ul style="list-style-type: none"> • LTE-FDD B2/B4/B12 • UMTS/HSPA+ B2/B5
Category	CAT1
Data Transmission	<p>HSPA+: up to 5.76 Mbps(UL), 42 Mbps(DL)</p> <p>LTE Category 1: up to 5 Mbps (UL), 10 Mbps (DL)</p>
Transmitting Power	<p>WCDMA: Class 3 (0.25W)</p> <p>LTE: Class 3 (0.25W)</p>
Features	<p>SMS</p> <p>Telephone Call with Text to Speech</p> <p>Internet (PPP) : email, VPN, cloud</p> <p>Optional GPS *</p> <p>+ GNSS: GPS/GLONASS/Beidou/Galileo</p> <p>+ GPS active antenna provided</p>
SIM card	<p>Standard SIM card size</p> <p>Support SAT class 3, GSM 11.14 Release 98</p>
Antenna	3m External Antenna
Components	Manufactured using highly integrated, low power surface mount technology to ensure long term reliability.
Operating Environment	<p>Temperature : Min. -20° C – Max.70° C</p> <p>Humidity: Min. 20% – Max. 80% (Non-Condensing)</p>
Certification	<p>EU Version :</p> <ul style="list-style-type: none"> • CE-RED • IMDA • GCF • RoHS • REACH <p>US Version :</p> <ul style="list-style-type: none"> • FCC • PTCRB • IC • RoHS • REACH
Carrier certification	<p>EU version :</p> <ul style="list-style-type: none"> • Deutsche Telekom / Vodafone <p>US version :</p> <ul style="list-style-type: none"> • AT&T / Rogers
Important Note	<p>This modem will support telephone call text to speech and GPS in future releases</p> <p>* GPS support on SP2+ and WTG only</p>

SPX+ Technical Drawing

SPX+ Standard Configurations

SPX4

SPX with 4 sensor ports

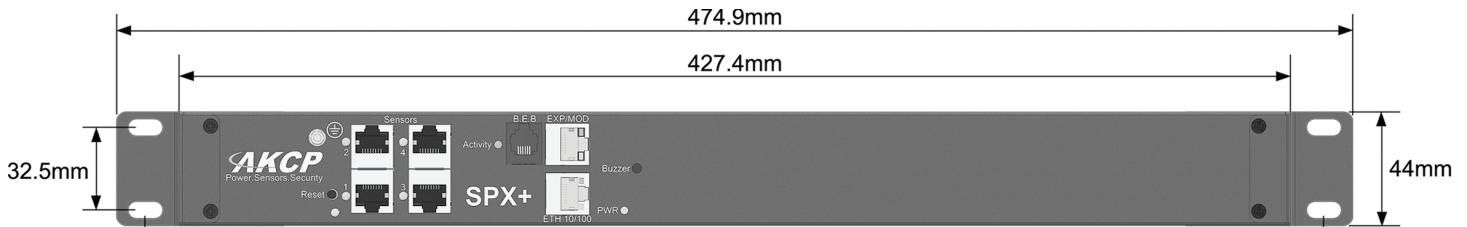

SPX8

SPX with 8 sensor ports

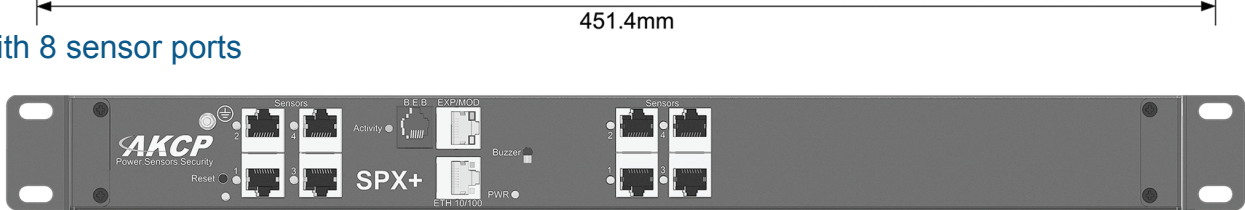

SPX4-X10

SPX with 4 sensor ports and 10 dry contacts



SPX8-X20

SPX with 8 sensor ports and 20 dry contacts

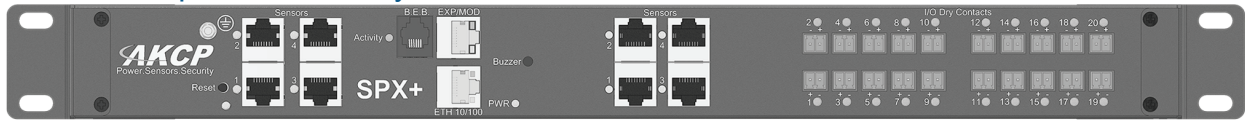

SPX8-X60

SPX with 8 sensor ports and 60 dry contacts

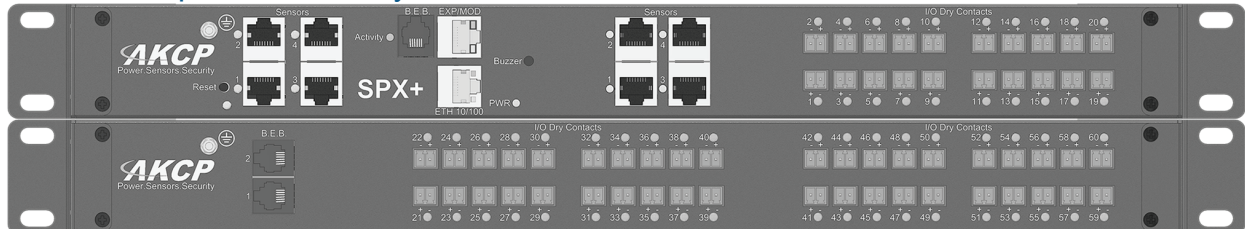

Top View

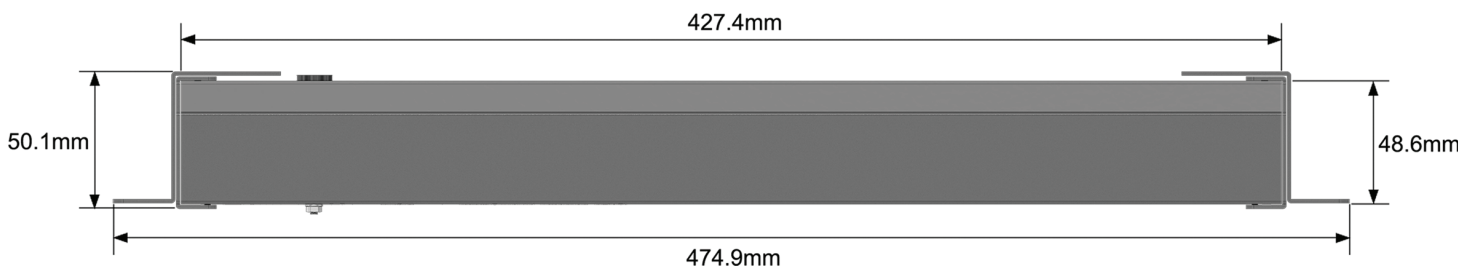

SPX+ Technical Drawing

Standard BEB Configurations

SPXB4

SPX BEB with 4 sensor ports

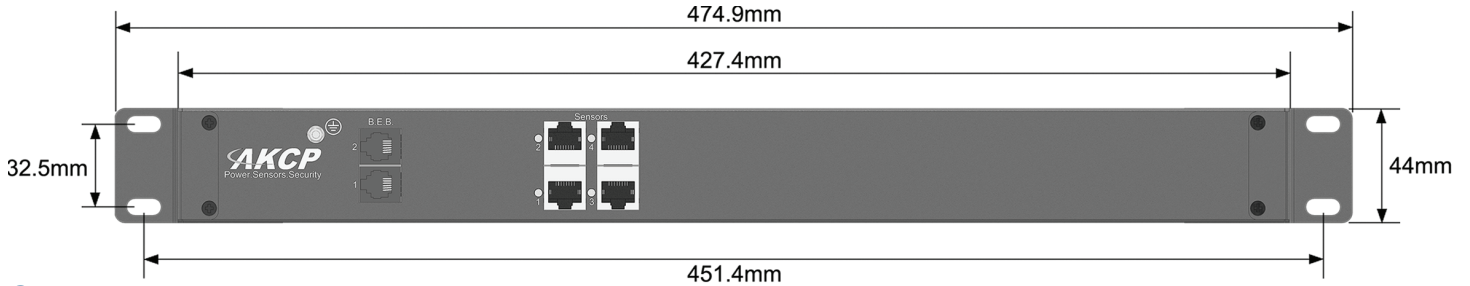

SPXB-X20

SPX BEB with 20 dry contacts

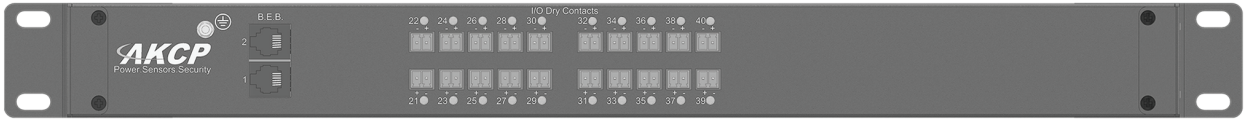

SPXB8-X20

SPX BEB with 8 sensor ports and 20 dry contacts

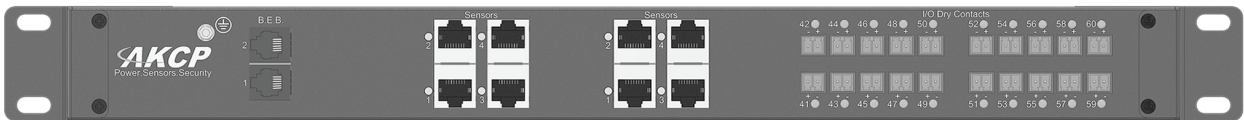

SPXB16

SPX BEB with 16 sensor ports

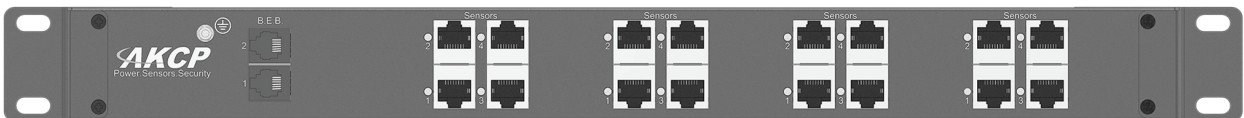

SPXB-X40

SPX BEB with 40 dry contacts

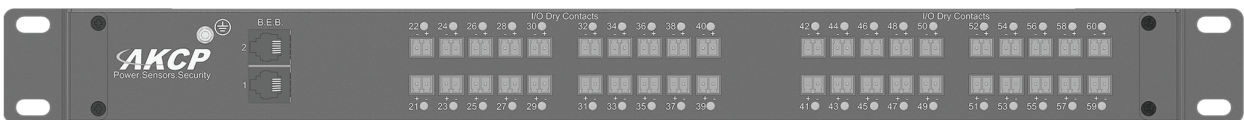

Top View

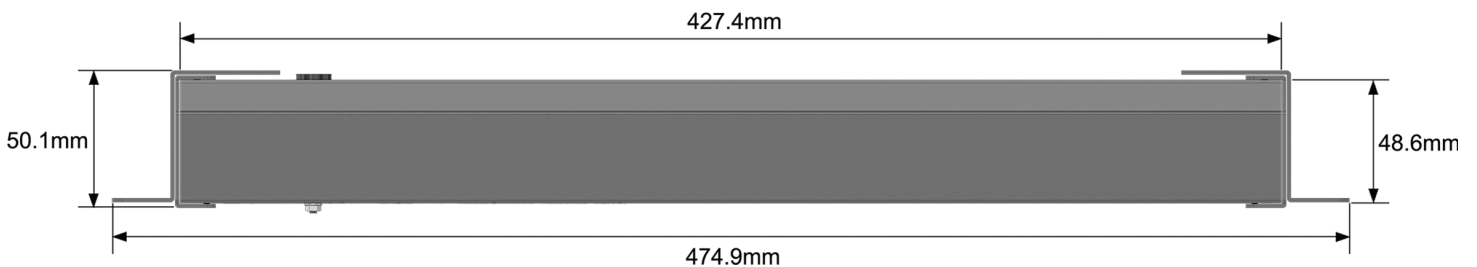

SPX+ Technical Drawing

SPX8-X60

SPX8-X60 is a 2U device, comprised of an SPX+ with BEB unit. This can be mounted in 2 separate U's, or back to back in the same U as illustrated below.

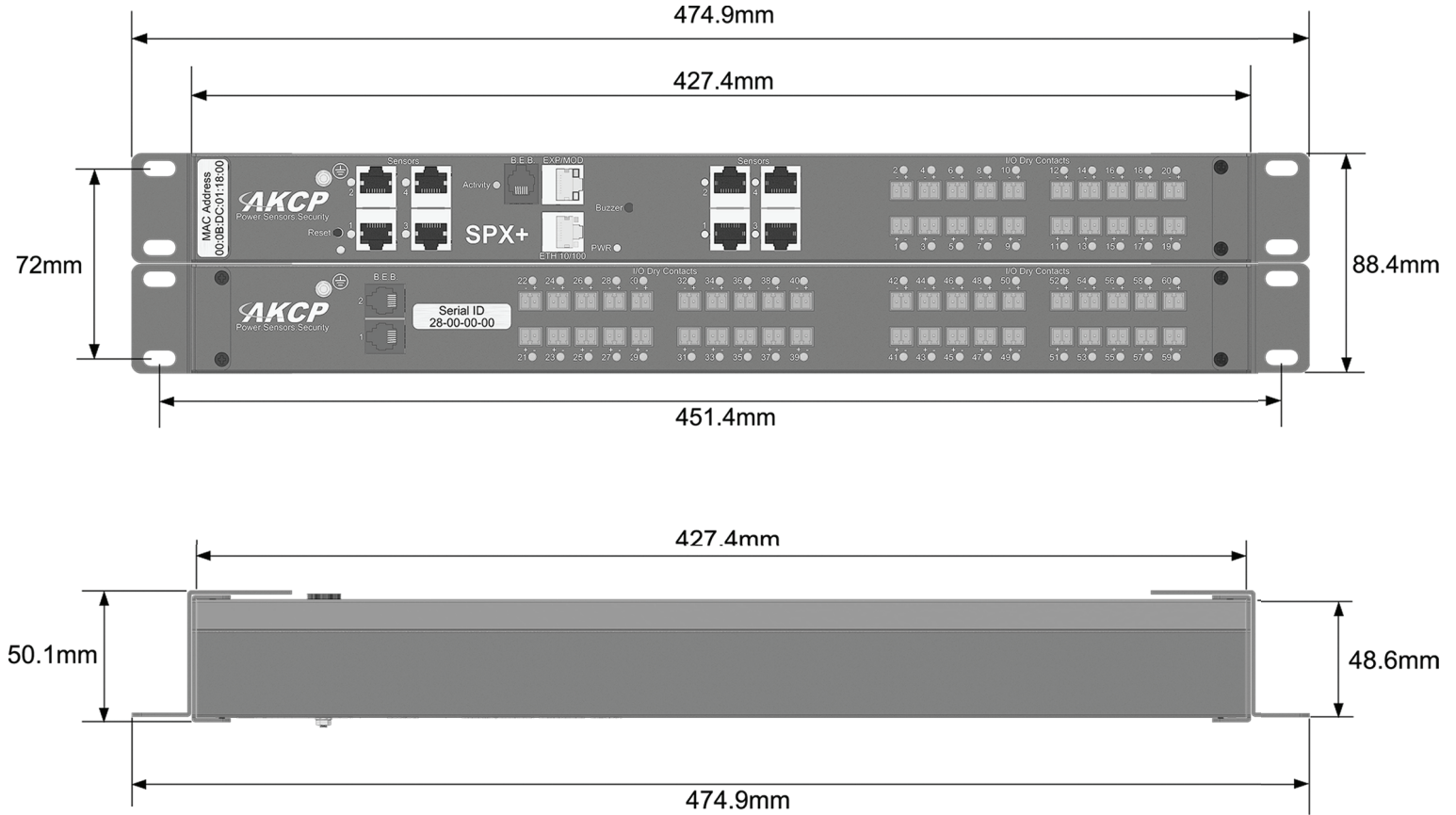

1U mounting of SPX8-X60 at front and rear of cabinet

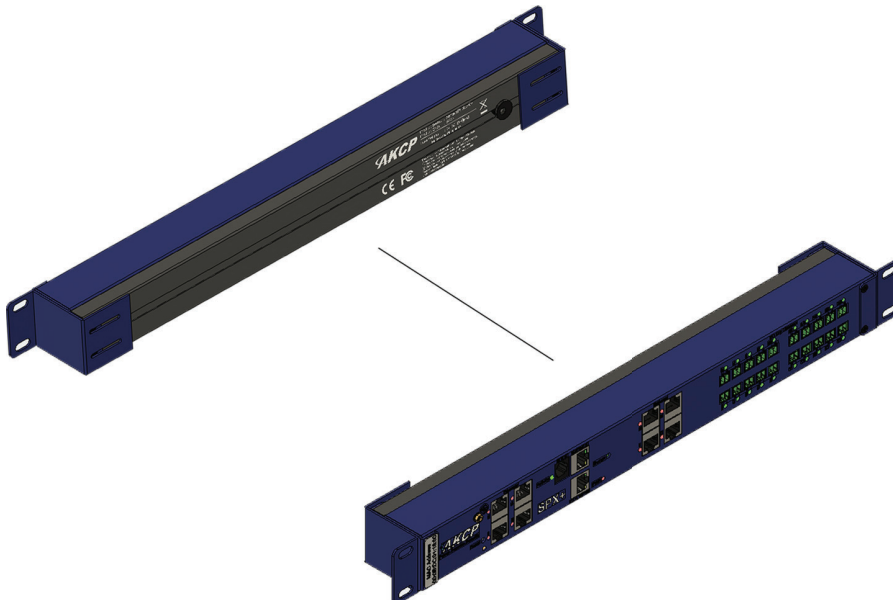

SPX+ Technical Drawing

0U SPX+ with 60x dry contacts
(configured as input only, I/O or opto isolated).

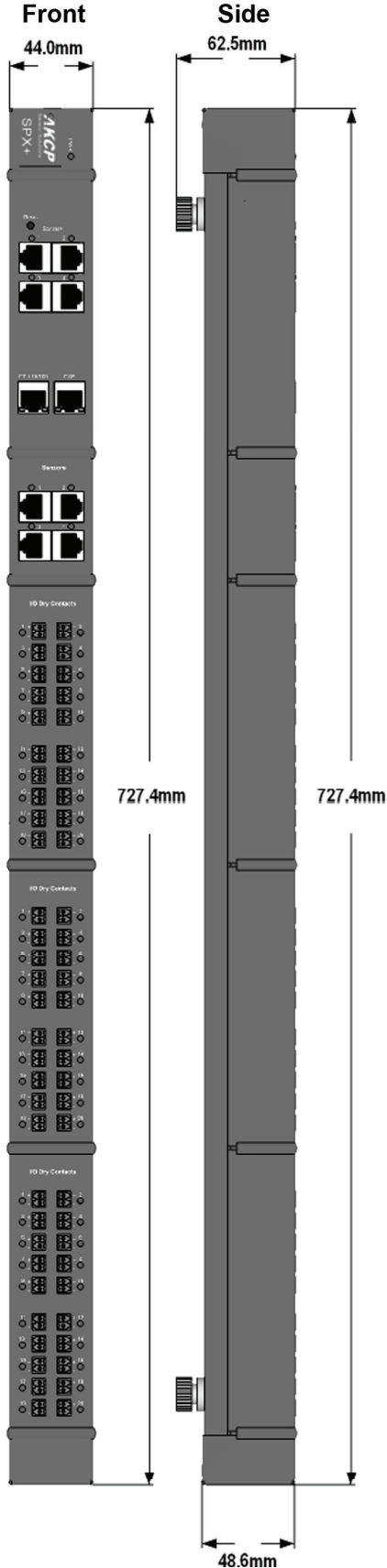

0U SPX+ with 12x sensor ports and 30x dry contacts
(configured as input only, I/O or opto isolated).

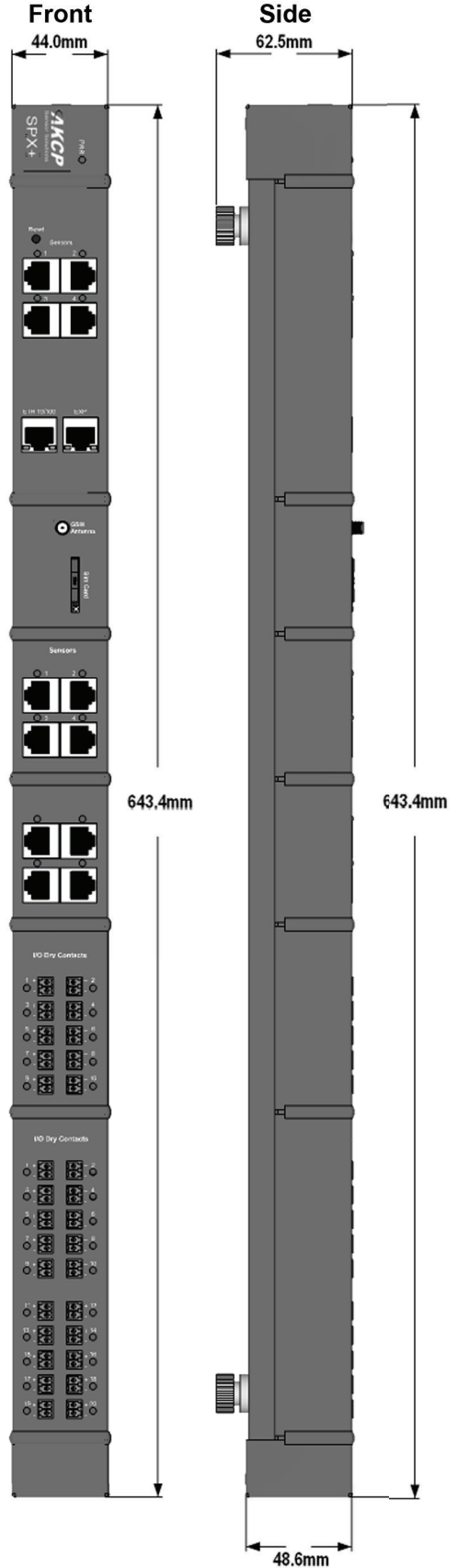

SPX+ Technical Drawing

0U SPX+ with DIN rail mounting

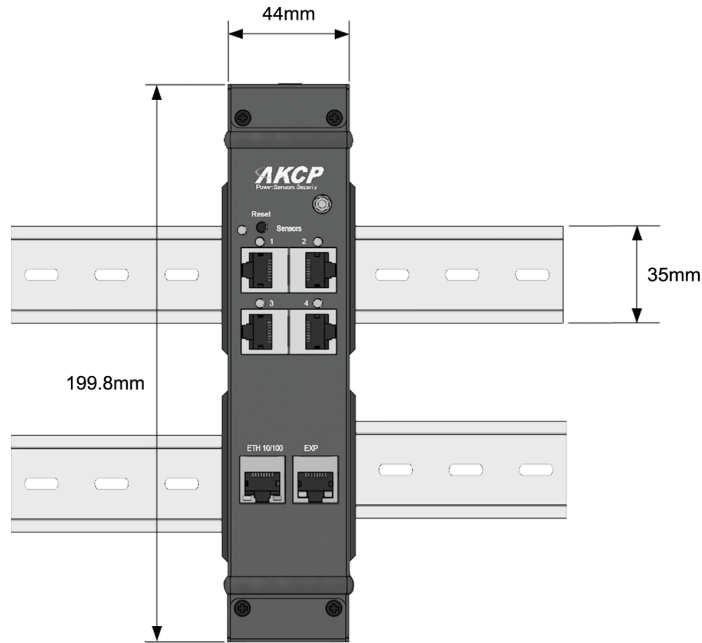

0U SPX+ with internal modem & DIN rail mounting

